

# 6005A/6005B Wash Unit

Welcome to use our products. A0  
Please read the user manual carefully before using the products.  
Our company reserves the right to improve design and modify  
the products without prior notice.

## 1. About This Manual

This manual shall only be used for the reference of operation of this particular model. If the manual is used for other purposes, we will not undertake any according consequences and responsibility. All information of this manual shall be protected by copyright and shall not be copied and translated in any part of this specification without the written consent of manufacturer.

## 2. Warning

- Power supply must be cut off when changing electrical components or maintaining and cleaning machines.
- The plug must be plugged into an outlet that is properly installed and grounded, to prevent the risk of fire and electric shock.
- Do not stand on this equipment.
- Do not allow children to play with and place the equipment in a place where children can avoid touching. Please adjust the backrest back to the highest position when you leave.
- Please do not place the equipment in damp place such as bathroom to avoid electric shock or other failure. The remote control should also avoid contact with water.
- Please do not place the equipment in places where painting/coating or oxygen providing during operation.
- Unless being monitored or instructed by personnel who can be responsible for their personal safety, the people who have physical obstacles, tactile disorders, mental disorders, lacking of experience, common sense of children, are not allow to use the equipment.
- Please contact distributor, service center or related personal with appropriate skill and experience for repairing if the plug is damaged, in case of any dangerous.
- Please make sure there is no accessible thing within the stroke during any operation of the beds.
- Operation should be processed by trained professionals.

## 3. Precautions

- This product should be used by an experienced person who must be familiar with the product structure, performance and instructions. And make the regular maintenance work.
- Read this manual carefully before installation, operation and adjustment. And please keep it well.
- This product shall not be used for single side or single point loading work.
- Please abide by the safety operating instructions of the product, do not overload load use the product, ensure that the safety protection devices of the product are complete and reliable in a timely manner to eliminate unsafe factors.
- Tighten bolts and nuts regularly to avoid failure caused by loose, sliding, vibration and falling off.
- The operator shall not disassemble the parts of the product during the maintenance of the product.
- This product shall not operate with faults. When abnormal phenomenon or abnormal sound is found, it must be stopped immediately for inspection and can be used again after troubleshooting.
- The operator must be familiar with the instructions in each chapter of the product to ensure personal and product safety.
- Please strictly follow the warning label attached to the product.
- During the maintenance, the operator shall not disassemble any parts of the bed at will.
- After every treatment, please only use neutral solution to clear the dust or stains on the product.
- When adjusting each part, please keep your hands, feet and head away from the position indicated by the arrow. (As shown in the photo)

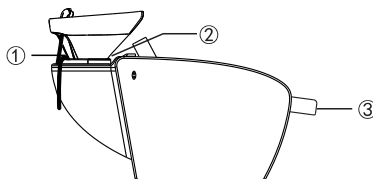

## 4. Caution

- Minors are not allowed to operate this product.
- Children younger than 14 years old and person who in state of dottiness are forbidden to operate it without supervised.
- Confirm supply voltage correspond to safety voltage (data plate of machine). Never start operation if voltage is not correct.
- Check the power cord before use. If it was destroyed, please ask a professional to service and replace it to avoid hazards, or contact the dealer for service.

## 5. Installation

1. Put the product to a proper location, according to the overall layout, the daylighting or artificial lightings and operation condition of the salon's or the home. And keep it in the clean, dry and cool environment.
2. Open the packing carton to check if the product is intact and whether the accessories or spares are complete. Please contact distributor or us if there's any problem.
3. Installation

Place the product to the proper position. Please note that it is unnecessary to install extra screw on the floor to fasten the bed, because the original design has taken the stability into consideration. But please ensure the product is placed on a firm and flat ground, so as to prevent any accident.

- Space to wash unit and wall

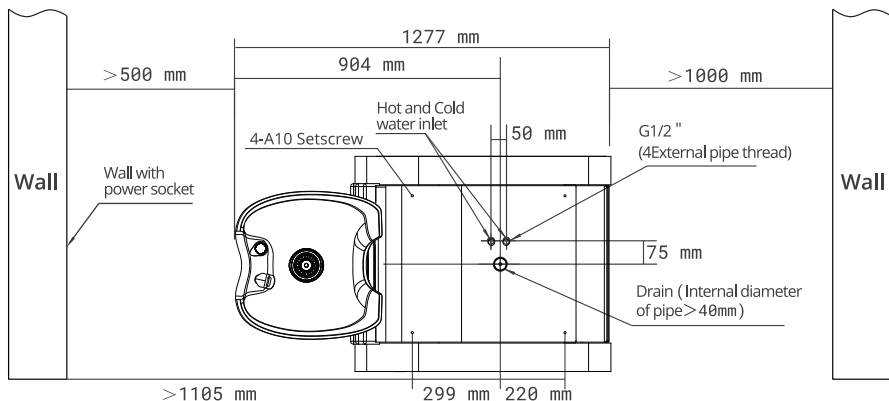
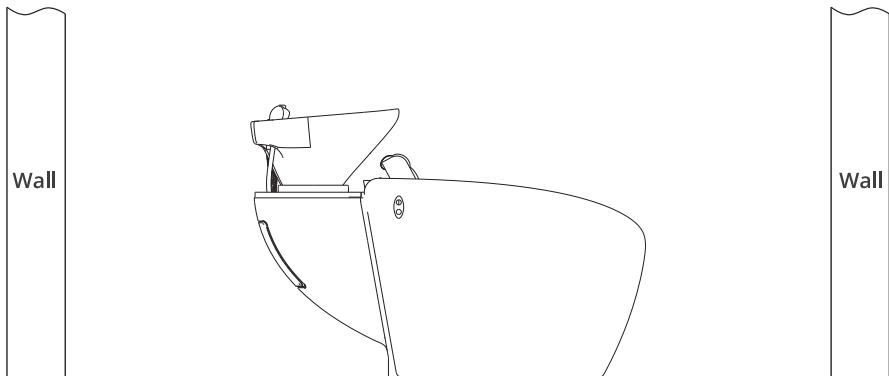

## 6. Major components

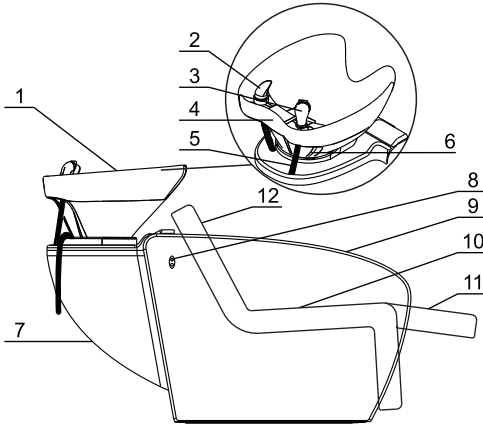

NO.	Name
1	Ceramic basin
2	Faucet switch
3	Shower head
4	Shower pedestal
5	Pipe
6	Basin tilt adjuster
7	Decoration of base
8	Control panel
9	Armrest
10	Seat
11	Footrest
12	Backrest

Pipes, valve and control button mentioned above are standard configuration. If there is any requirement, please contact dealer or manufacturer.

## 7. Operation

### ● Instruction of tilting ceramic basin

Tilt ceramic basin to appropriate angle according to client's request. See figure. Adjust part 1 to tighten or loosen the basin. Adjust part 2 to tilt the basin.

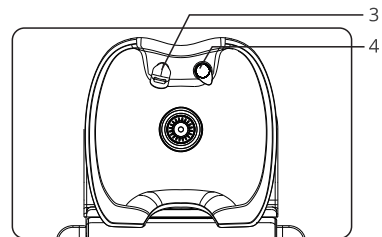
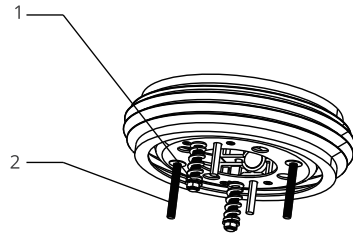
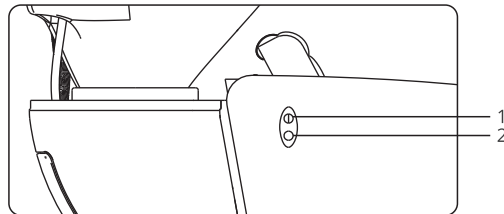

### ● Instruction of button panel and operation

NO.	Button Panel		Operation
1	6005A	UP	Footrest goes up
2		DOWN	Footrest goes down
1	6005B	UP	Footrest elevates, seat tilts, backrest reclines, align all sections with chaise longue mechanism.
2		DOWN	Seat goes down, all sections go back to seating position

NO.	Button Panel	Operation
3	Spray mode of shower head	Shower switch for swapping Rain mode / Massage mode
4	Water temperature and yield	Pointer to left / right for switching warm / cold water supply. Pointer to up / down for adjusting water yield.

After each operation or when the wash unit is not in use, please ensure seat be back to lowest position. Press button of "DOWN" if wash unit is not in seating position.

## 8. Technical Parameters

Power	AC 100-120V or AC 220-240V or AC 100-240V, 50/60Hz
Maximum Power	300W
Environmental Temperature	0°C ~ +40°C
Relative Humidity	30%~90%
Lifting Rated Load	175kg
Package Size	144×80×113cm

### 6005A

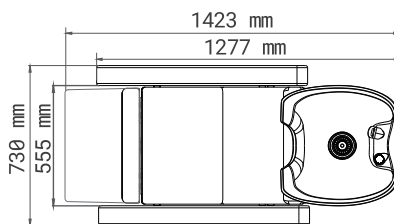
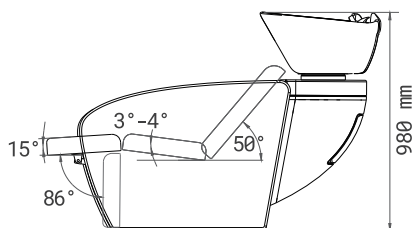

### 6005B

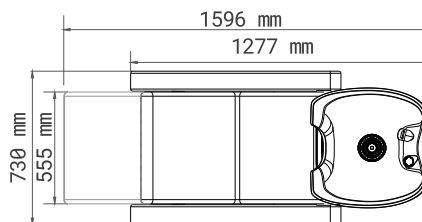
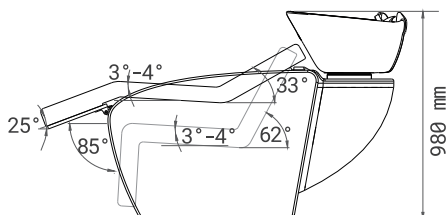

## 9. Electric Circuit



## 10. Principle of water channel

- The water connection principle of shampoo basin is as follows.

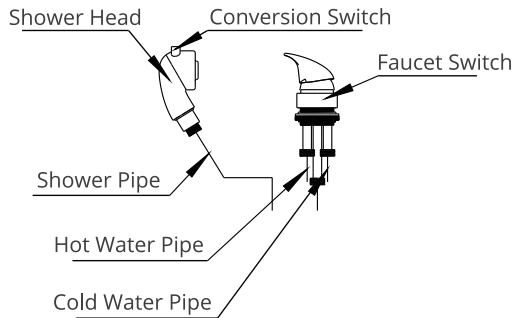

## 11. Specification

- See spec and diameter of drainer, shower head, faucet.

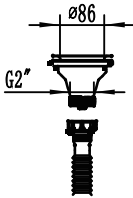

Diameter of drainer

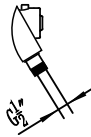

Shower head

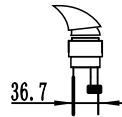

Faucet

## 12. Maintenance

1. After every treatment, please only use neutral solution to clear the the dust, stains on leather, metal part or other parts. Disinfecting solution like alcohol, acid or alkaline solution are forbidden. This is to prevent the lifetime of the components from being shortened.
2. Please lubricate the moving parts regularly (once a year)

## 13. Troubleshooting

The Fault Phenomenon	Reason	Solution
Do not work when press button	1. At the maximum position	Press another button
	2. Do not plug in or well connect with power supply.	Unplug and re-plug with power supply
	3. Connectors got loose	Reconnect the connector
Abnormal noise or shaking problem	Screws or bolts got loose	Tighten the screws or bolts

If problem is still not solved after above operations, please contact maintenance center or supplier to solve it.



Do not dispose of old or defective appliances in domestic garbage; this should only be done through public collection points.

▲ Please check the product specification before use. This manual is for reference only. Specifications are subject to change without prior notice.